

# SYNCHRONISATION OF INFORMATION

*RODIN 2020 Summer Camp*

David Bisset

• 11/06/2020

# Why share information?

Working group on “Information Synchronisation”

Purpose:

To discover what information adds value

Work out how to collect it

# Where is the valuable information?

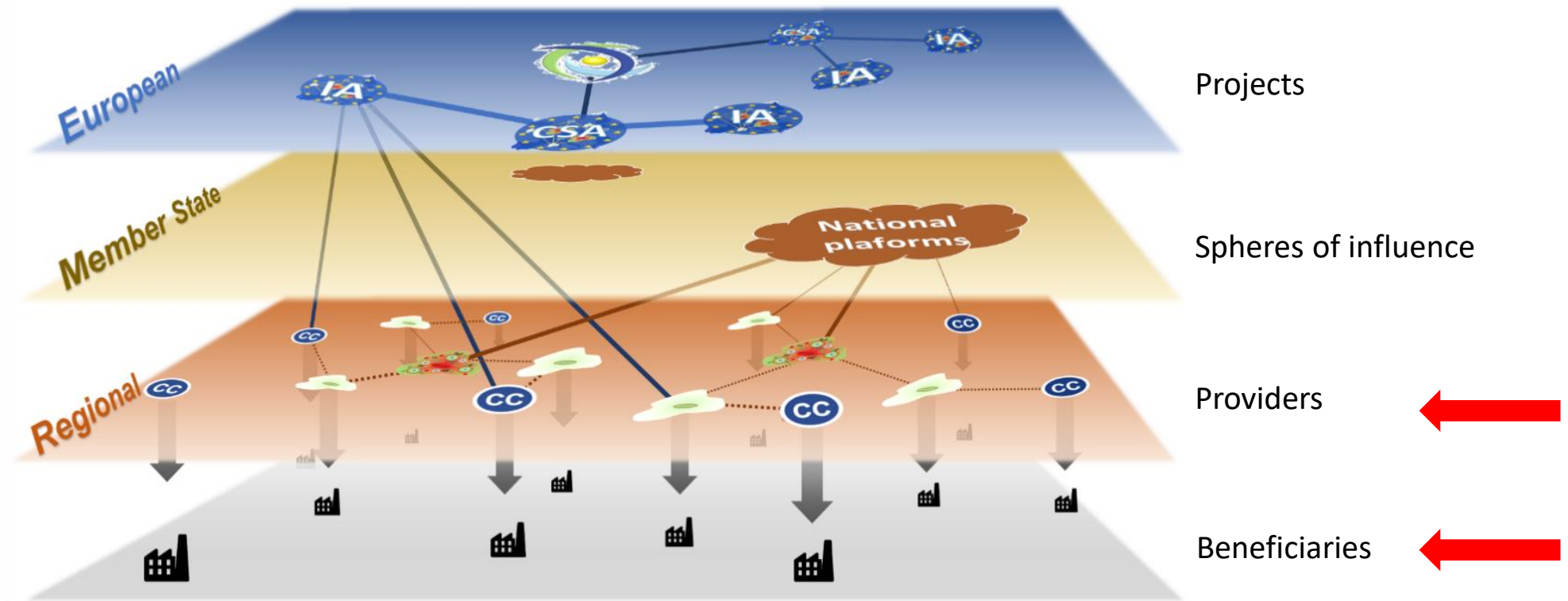

# Where is the information?

**HUB:**  
the **central** or main part of something where there is most **activity**:

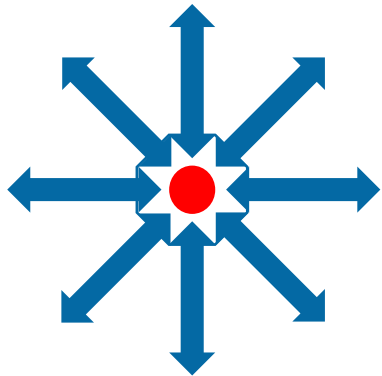

*...flow inward and outward  
to and from the centre...*

**NETWORK:** a **large** systems consisting of **many similar parts** that are **connected** together:

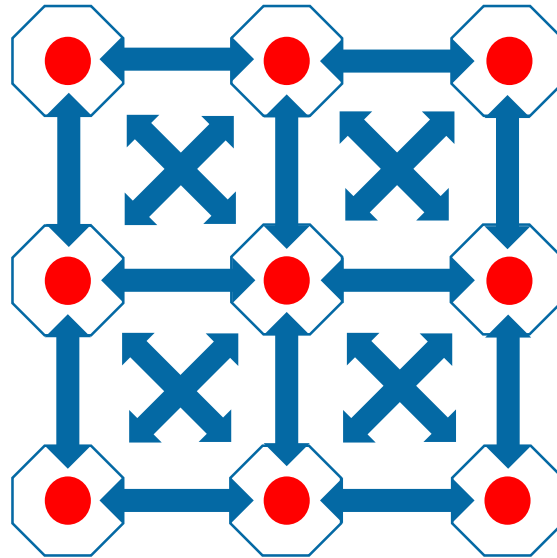

*... flow **between** nodes...*

**ECO-SYSTEM:** a **group** of **business innovation activities** that affect each other and **work well together**:

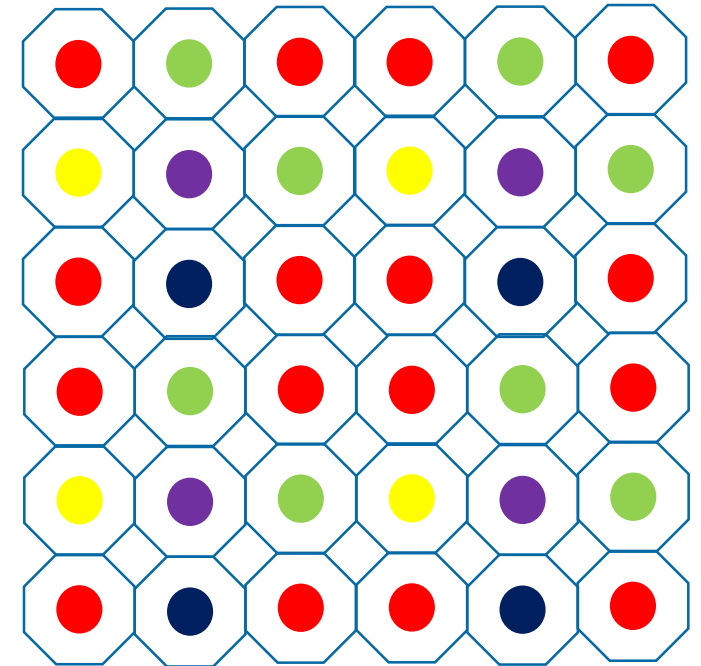

*...**multi-layer flow** between networks and nodes...*

# What information

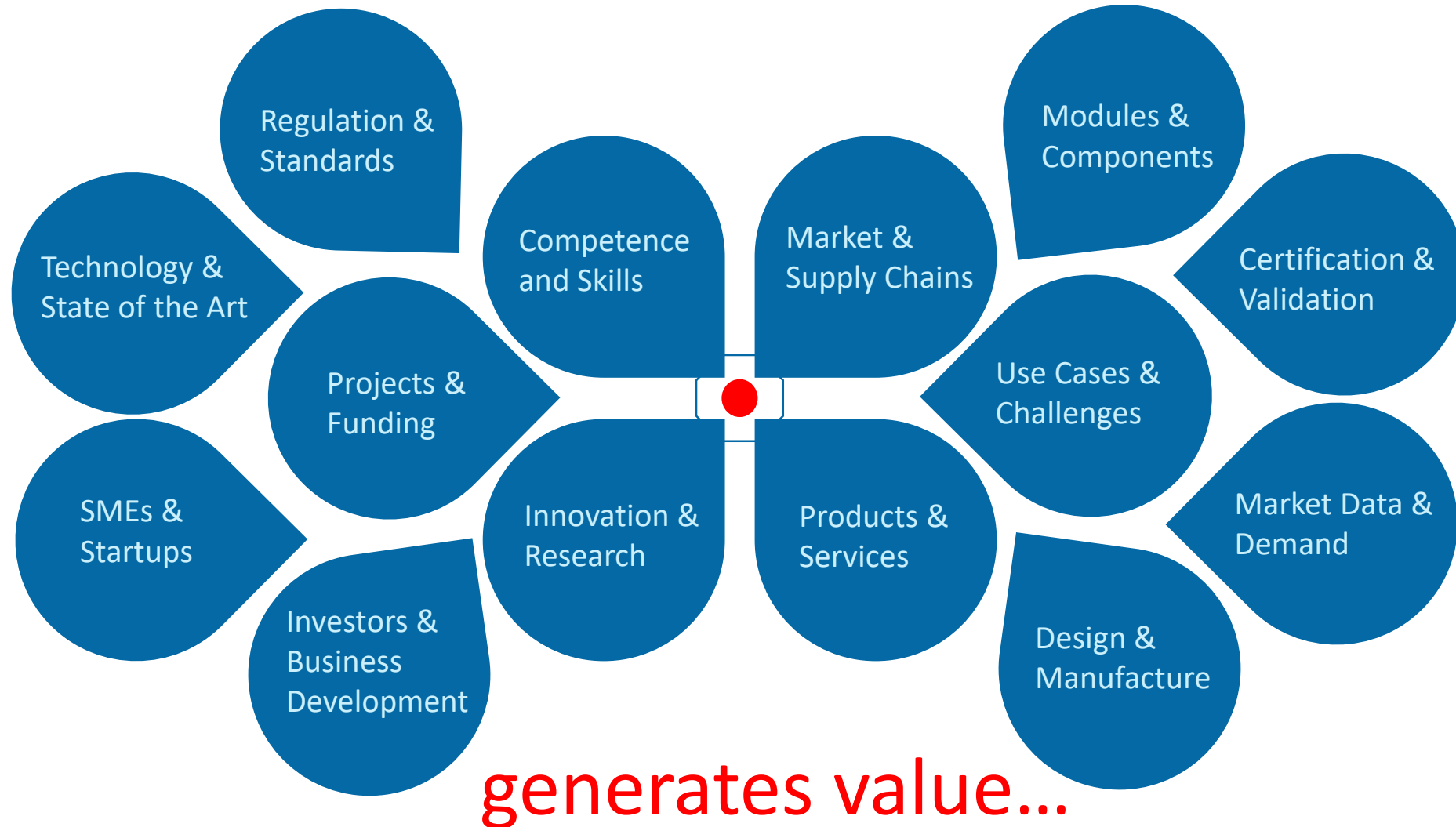

# What DIH information?

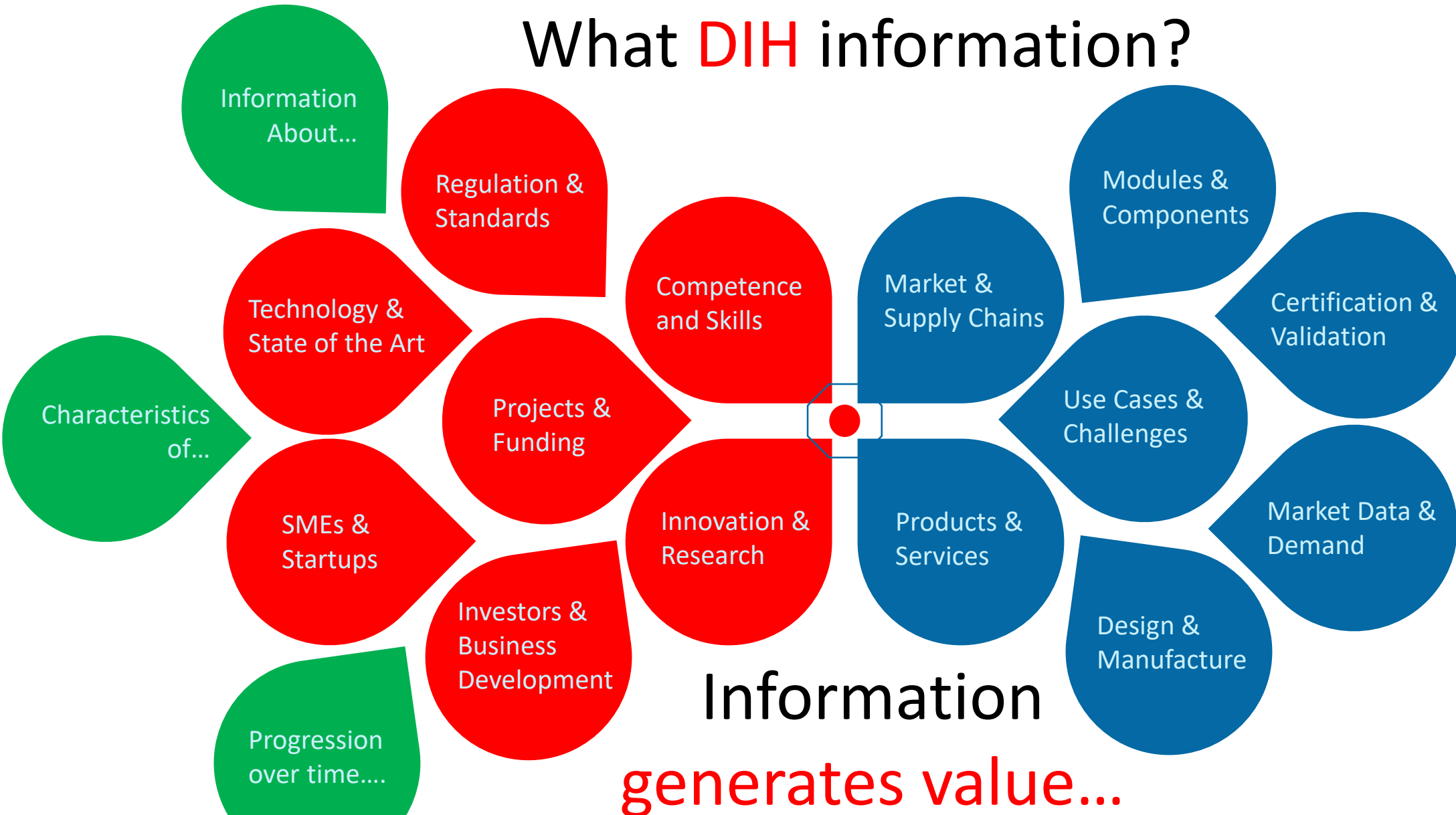

# Who gains value...

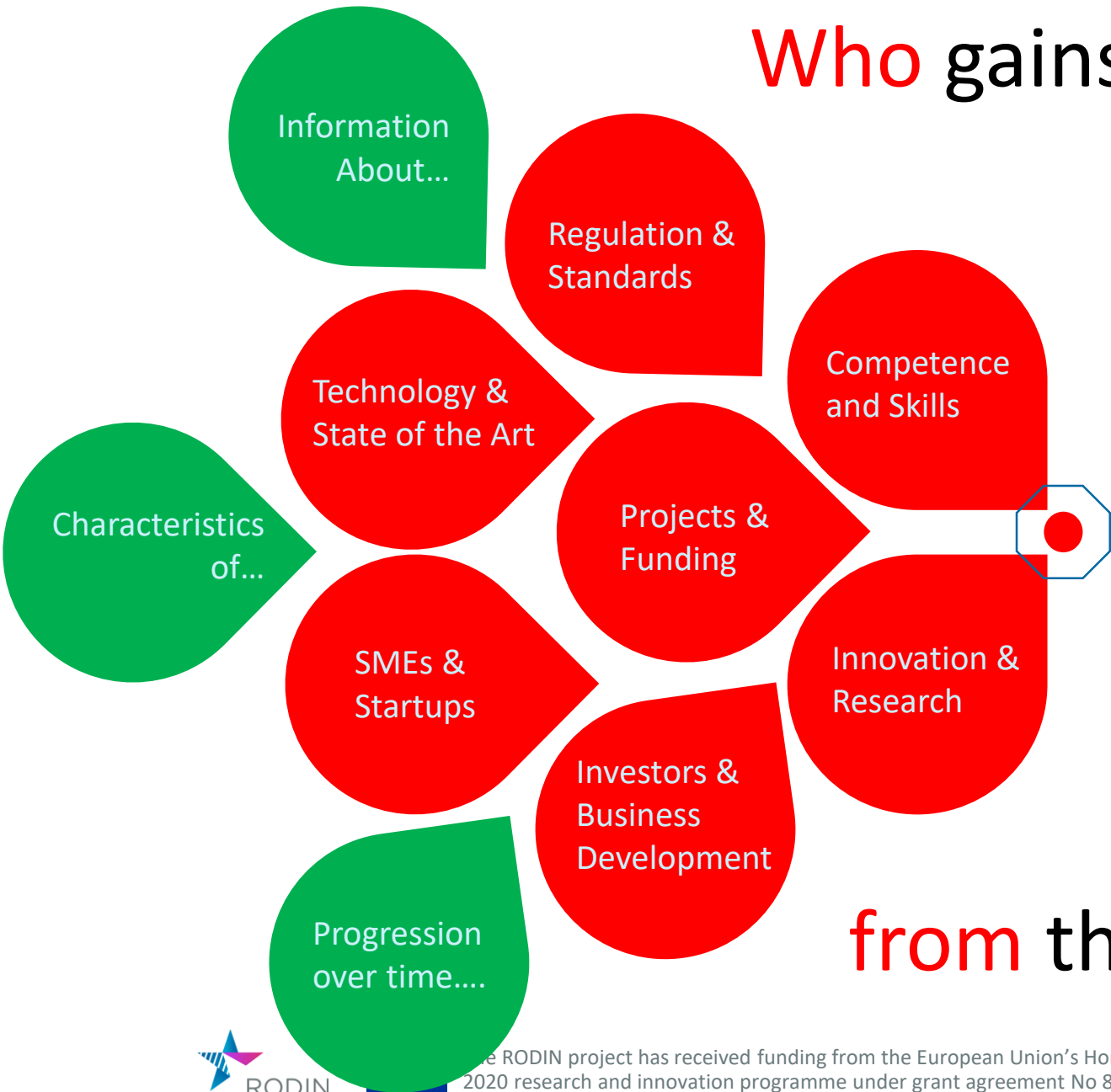

Performance & Monitoring



Access to expertise

from the eco-system



# Can **you** gain value...

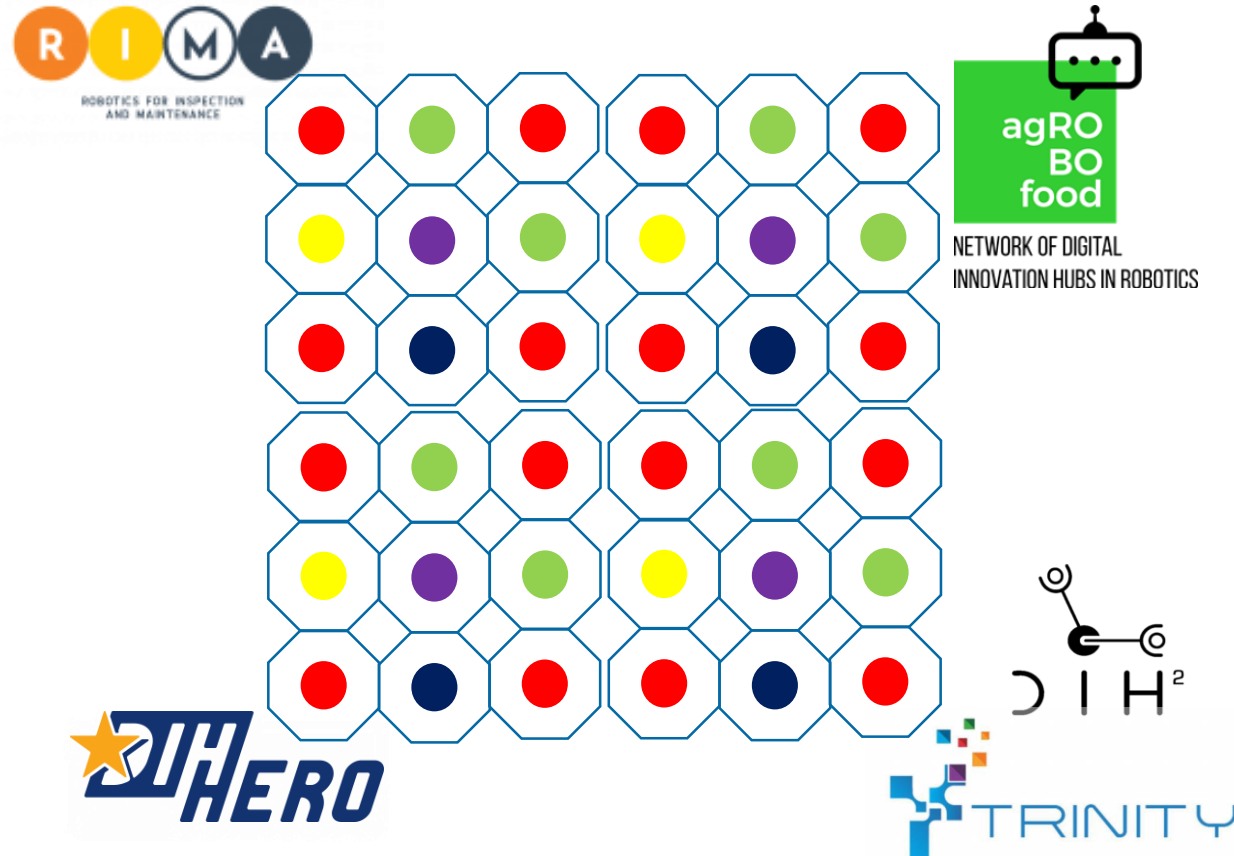

*...for stakeholders*  
*...for sustainability*  
*...for self-assessment*  
*...for services*

by **sharing** information...



# What information could **you** share?

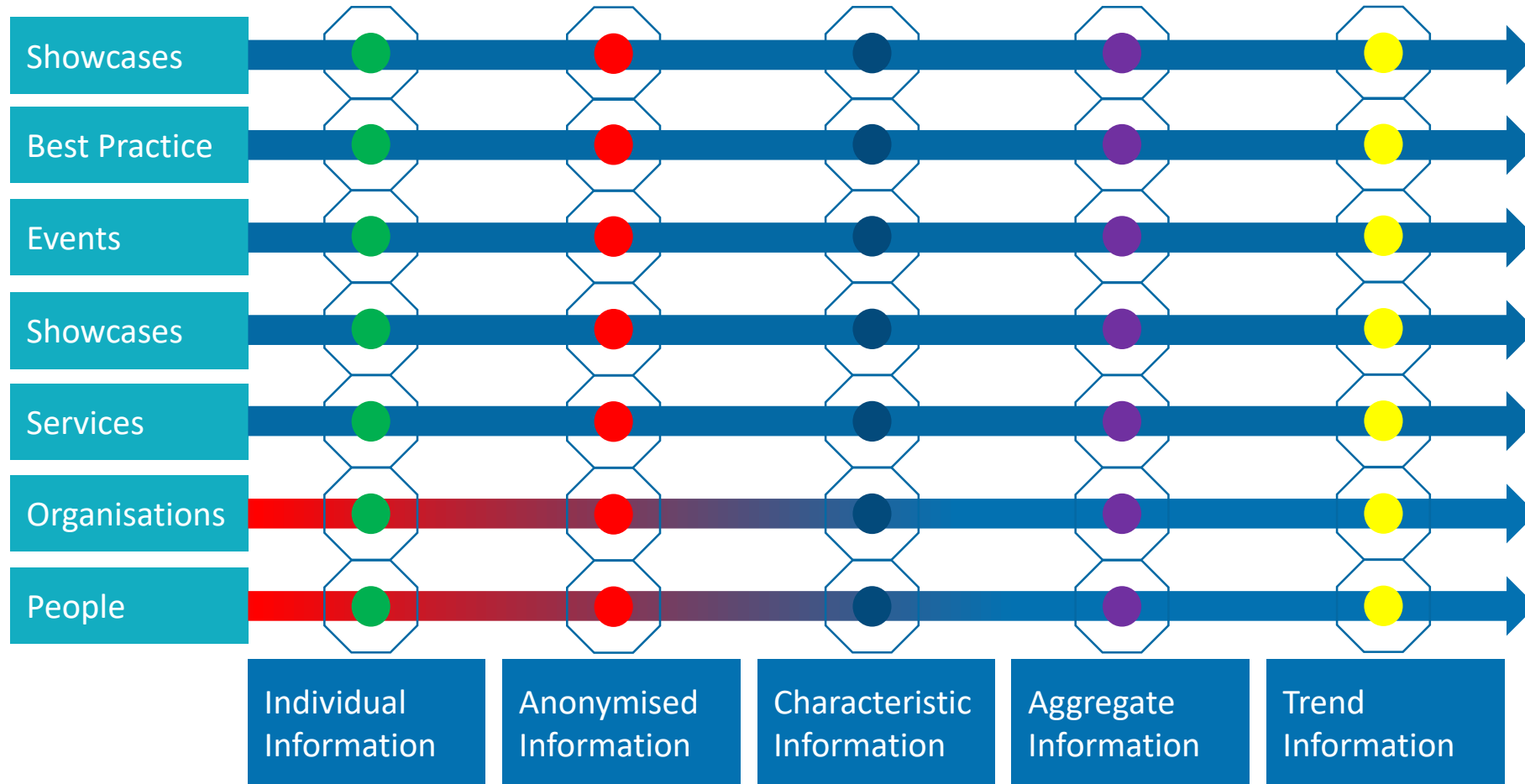

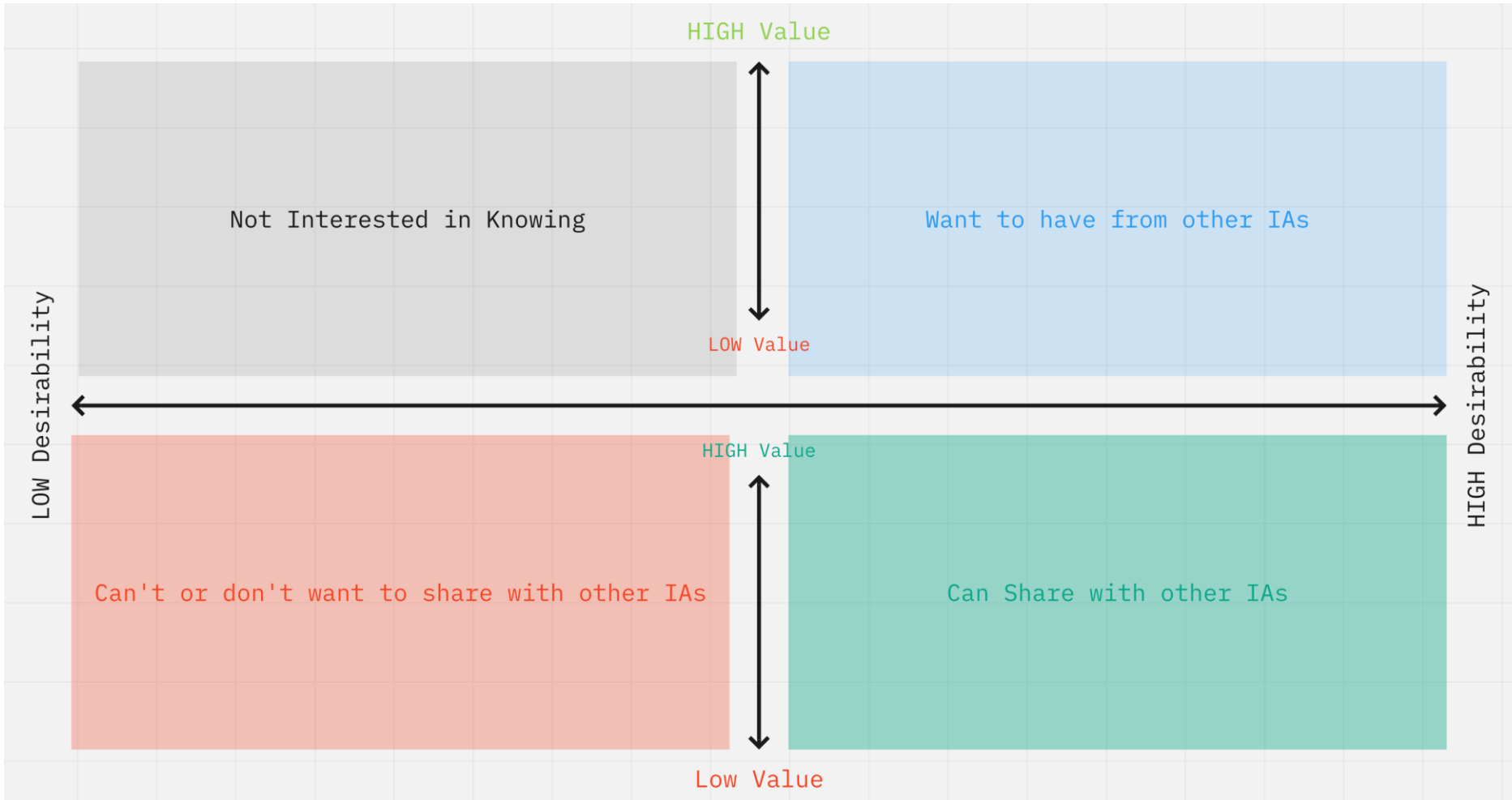

What is the **value gain** from sharing?

We will convene the  
“Information Synchronisation”  
Working Group.



CONTACTS

[info@rodin-robotics.eu](mailto:info@rodin-robotics.eu)

2020